

## Data sheet | Item number: 281-601

2-conductor through terminal block; 4 mm<sup>2</sup>; lateral marker slots; for DIN-rail  
35 x 15 and 35 x 7.5; CAGE CLAMP®

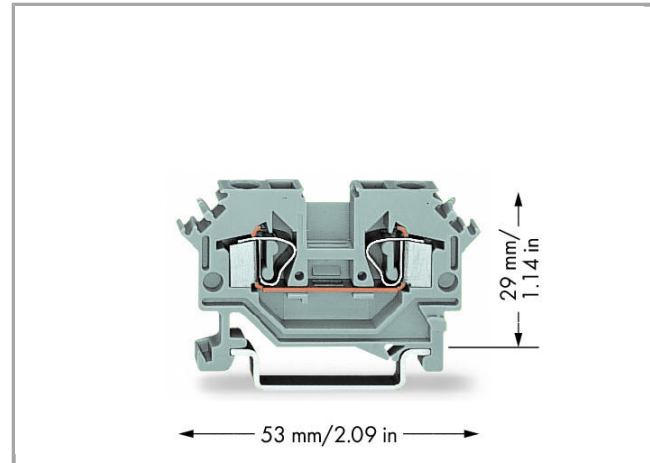

281-601

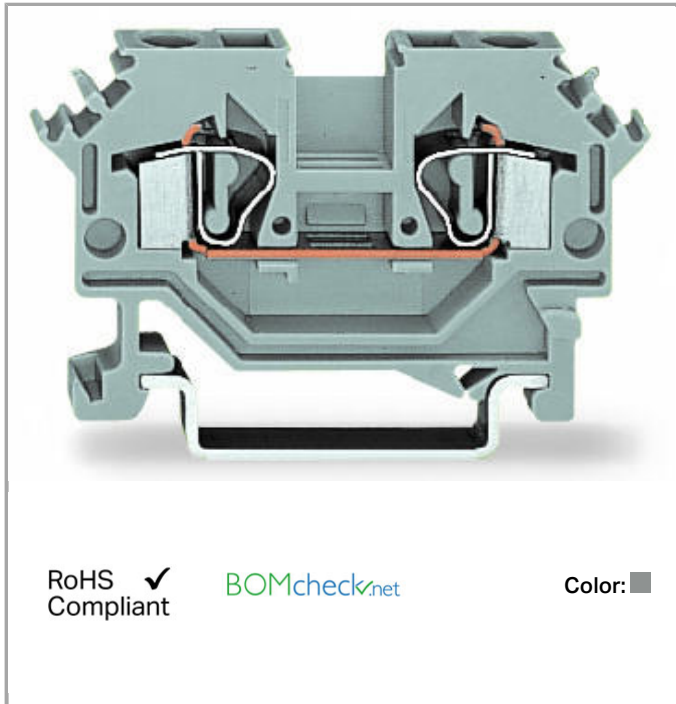

RoHS Compliant

[BOMcheck.net](https://www.bomcheck.net)

Color:

### Item description

#### Note:

##### Terminating Aluminum Conductors

WAGO spring clamp terminal blocks are suitable for solid aluminum conductors up to 4 mm<sup>2</sup>/12 AWG if WAGO "Alu-Plus" Contact Paste is used for termination.

"Alu-Plus" Contact Paste Advantages:

- Automatically destroys the oxide film during clamping.
- Prevents fresh oxidation at the clamping point.
- Prevents electrolytic corrosion between aluminum and copper conductors (in the same terminal block).
- Provides long-term protection against corrosion.

Using terminal blocks with CAGE CLAMP® Spring Pressure Connection Technology, **aluminum conductors must first be cleaned with a blade** and then immediately be inserted into the clamping units filled with "Alu-Plus" Contact Paste.

It is also possible to apply WAGO "Alu-Plus" **additionally** on the whole surface of the aluminum conductor before termination.

Please note that the nominal currents must be adapted to the reduced conductivity of the aluminum conductors:

2.5 mm<sup>2</sup> (14 AWG) = 16 A

4 mm<sup>2</sup> (12 AWG) = 22 A

## Data

### Electrical data

#### Ratings per IEC/EN 60664-1

Rated voltage (III / 3)	800 V
Rated impulse voltage (III / 3)	8 kV
Rated current	32 A

### Connection data

Connection technology	CAGE CLAMP®
Actuation type	Operating tool
Connectable conductor materials	Copper Aluminum
Solid conductor	0.08 ... 4 mm <sup>2</sup> / 28 ... 12 AWG
Fine-stranded conductor	0.08 ... 4 mm <sup>2</sup> / 28 ... 12 AWG
Strip length	9 ... 10 mm / 0.35 ... 0.39 inch
Total number of connection points	2
Total number of potentials	1
Number of levels	1
Type of wiring	Front-entry wiring

### Geometrical Data

Width	6 mm / 0.236 inch
Height from upper-edge of DIN-35 rail	29 mm / 1.142 inch
Depth	53 mm / 2.087 inch

### Mechanical data

Design	horizontal
Type of mounting	DIN-35 rail
Marking level	Side marking

### Material Data

Color	gray
Insulating material	Polyamide 66 (PA 66)
Fire load	0.128 MJ
Weight	7.03 g





### Commercial data

Product Group	1 (Rail Mounted Terminal Blocks)
---------------	----------------------------------





Country of origin	DE
GTIN	4044918500579
Customs Tariff No.	85369010000

## Approvals / Certificates

### Country specific Approvals

Logo	Approval	Additional Approval Text	Certificate name
	CCA DEKRA Certification B.V.	EN 60947	NTR NL-7454/A1
	CCA DEKRA Certification B.V.	IEC 60947	NTR NL-7454/A1
	CSA DEKRA Certification B.V.	C22.2 No. 158	1505034
	KEMA/KEUR DEKRA Certification B.V.	EN 60947	71-107288

### Ship Approvals

Logo	Approval	Additional Approval Text	Certificate name
	ABS American Bureau of Shipping	-	14-HG1293677-PDA
	BV Bureau Veritas S.A.	EN 60947	07436/E0 BV
	DNV GL Det Norske Veritas, Germanischer Lloyd	-	TAE00001V2
	LR Lloyds Register	EN 60947	91/20112 (E9)











### UL-Approvals

Certificate

Logo	Approval	Additional Approval Text	name
	UR Underwriters Laboratories Inc.	UL 1059	E45172











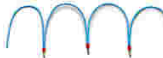





## Compatible products

















### Carrier rail

















	<b>Item no.: 210-112</b> Steel carrier rail; 35 x 7.5 mm; 1 mm thick; 2 m long; slotted; according to EN 60715; "Hole width 25 mm	210-112
	<b>Item no.: 210-113</b> Steel carrier rail; 35 x 7.5 mm; 1 mm thick; 2 m long; unslotted; according to EN 60715	210-113
	<b>Item no.: 210-114</b> Steel carrier rail; 35 x 15 mm; 1.5 mm thick; 2 m long; unslotted; similar to EN 60715	210-114
	<b>Item no.: 210-115</b> Steel carrier rail; 35 x 7.5 mm; 1 mm thick; 2 m long; slotted; according to EN 60715; "Hole width 18 mm	210-115
	<b>Item no.: 210-118</b> Steel carrier rail; 35 x 15 mm; 2.3 mm thick; 2 m long; unslotted; according to EN 60715	210-118
	<b>Item no.: 210-196</b> Aluminum carrier rail; 35 x 8.2 mm; 1.6 mm thick; 2 m long; unslotted; similar to EN 60715	210-196
	<b>Item no.: 210-197</b> Steel carrier rail; 35 x 15 mm; 1.5 mm thick; 2 m long; slotted; similar to EN 60715	210-197
	<b>Item no.: 210-198</b> Copper carrier rail; 35 x 15 mm; 2.3 mm thick; 2 m long; unslotted; according to EN 60715	210-198
	<b>Item no.: 210-504</b> Steel carrier rail; 35 x 7.5 mm; 1 mm thick; 2 m long; slotted; galvanized; according to EN 60715	210-504
	<b>Item no.: 210-505</b> Steel carrier rail; 35 x 7.5 mm; 1 mm thick; 2 m long; unslotted; galvanized; according to EN 60715	210-505
	<b>Item no.: 210-506</b> Steel carrier rail; 35 x 15 mm; 1.5 mm thick; 2 m long; unslotted; galvanized; similar to EN 60715	210-506

















	<b>Item no.: 210-508</b> Steel carrier rail; 35 x 15 mm; 1.5 mm thick; 2 m long; slotted; galvanized; similar to EN 60715	210-508
--	--	---------

















### Jumper

	<b>Item no.: 210-103</b> Wire commoning chain; insulated; 50 connections	210-103
	<b>Item no.: 210-123</b> Wire commoning chain; insulated; 50 connections	210-123
	<b>Item no.: 249-123</b> Push-in type wire jumper; insulated; wire length 180 mm; Conductor cross section 0.75 mm <sup>2</sup>	249-123
	<b>Item no.: 249-125</b> Push-in type wire jumper; insulated; wire length 60 mm; Conductor cross section 0.75 mm <sup>2</sup>	249-125
	<b>Item no.: 249-126</b> Push-in type wire jumper; insulated; wire length 110 mm; Conductor cross section 0.75 mm <sup>2</sup>	249-126
	<b>Item no.: 249-127</b> Push-in type wire jumper; insulated; wire length 250 mm; Conductor cross section 0.75 mm <sup>2</sup>	249-127
	<b>Item no.: 281-402</b> Adjacent jumper; insulated; IN = IN terminal block	281-402
	<b>Item no.: 281-409</b> Alternate jumper; insulated; IN = IN terminal block	281-409
	<b>Item no.: 281-422</b> Adjacent jumper; insulated; IN = IN terminal block	281-422
	<b>Item no.: 281-482</b> Comb-style jumper bar; insulated; 2-way; IN = IN terminal block	281-482
	<b>Item no.: 281-483</b> Comb-style jumper bar; insulated; 3-way; IN = IN terminal block	281-483
	<b>Item no.: 281-485</b> Comb-style jumper bar; insulated; 5-way; IN = IN terminal block	281-485
	<b>Item no.: 281-490</b> Comb-style jumper bar; insulated; 10-way; IN = IN terminal block	281-490
	<b>Item no.: 281-492</b> Alternate comb-style jumper bar; insulated; 2-way; IN = IN terminal block	281-492
	<b>Item no.: 283-414</b> Step-down jumper; insulated; from 16 mm <sup>2</sup> to 4 mm <sup>2</sup> ; Nominal current 32 A	283-414
	<b>Item no.: 284-413</b> Step-down jumper; insulated; from 10/6 mm <sup>2</sup> to 6/4 mm <sup>2</sup> ; Nominal current 30 A	284-413
	<b>Item no.: 284-414</b> Step-down jumper; insulated; from 10/6 mm <sup>2</sup> to 4/2.5/1.5 mm <sup>2</sup> ; Nominal current 15 A	284-414
	<b>Item no.: 709-110</b> Wire commoning chain; insulated; 4 connections; 3 x 110 mm	709-110

	Item no.: 709-111 Wire commoning chain; insulated; 3 connections; 2 x 120 mm	709-111
	Item no.: 709-112 Wire commoning chain; insulated; 3 connections; 2 x 170 mm	709-112
	Item no.: 781-452 Staggered jumper; insulated; from 1 to 2; Spacing: 6 mm	781-452
	Item no.: 781-453 Staggered jumper; insulated; from 1 to 3; Spacing: 6 mm	781-453
	Item no.: 781-454 Staggered jumper; insulated; from 1 to 4; Spacing: 6 mm	781-454
	Item no.: 781-455 Staggered jumper; insulated; from 1 to 5; Spacing: 6 mm	781-455
	Item no.: 781-456 Staggered jumper; insulated; from 1 to 6; Spacing: 6 mm	781-456
<b>Insulation stop</b>		
	Item no.: 281-470 Insulation stop; 0.08 - 0.2 mm <sup>2</sup> "s" (0.14 mm <sup>2</sup> "f-st"); 5 pieces/strip	281-470
	Item no.: 281-471 Insulation stop; 0.25 - 0.5 mm <sup>2</sup> ; 5 pieces/strip	281-471
	Item no.: 281-472 Insulation stop; 0.75 - 1.5 mm <sup>2</sup> ; 5 pieces/strip	281-472
<b>Protective Warning Marker</b>		
	Item no.: 281-415 Protective warning marker; with high-voltage symbol, black; for 5 terminal blocks	281-415
<b>check</b>		
	Item no.: 209-170 Test plug adapter; 8.3 mm wide; for 4 mm Ø test plugs; suitable for 1.5 mm <sup>2</sup> - 10 mm <sup>2</sup> tbs	209-170
<b>assembling</b>		
	Item no.: 209-106 Mounting carrier; for isolated mounting on DIN 35 rails	209-106
	Item no.: 709-153 Cover; Type 1; suitable for cover carrier, type 1; 1 m long	709-153
<b>Marking accessories</b>		
	Item no.: 2009-115 WMB-Inline; for Smart Printer; on reel; stretchable 5 - 5.2 mm; plain; snap-on type	2009-115
	Item no.: 2009-115/000-002 WMB-Inline; for Smart Printer; on reel; stretchable 5 - 5.2 mm; plain; snap-on type	2009-115 /UUU-UUZ
	Item no.: 2009-115/000-006 WMB-Inline; for smartPRINTER; on reel; stretchable 5 - 5.2 mm; plain; snap-on type	2009-115 /UUU-UUB

	<b>Item no.: 2009-115/000-007</b> WMB-Inline; for Smart Printer; on reel; stretchable 5 - 5.2 mm; plain; snap-on type	/000-007	2009-115
	<b>Item no.: 2009-115/000-012</b> WMB-Inline; for smartPRINTER; on reel; stretchable 5 - 5.2 mm; plain; snap-on type	/000-012	2009-115
	<b>Item no.: 2009-115/000-017</b> WMB-Inline; for Smart Printer; on reel; stretchable 5 - 5.2 mm; plain; snap-on type	/000-017	2009-115
	<b>Item no.: 2009-115/000-023</b> WMB-Inline; for Smart Printer; on reel; stretchable 5 - 5.2 mm; plain; snap-on type	/000-023	2009-115
	<b>Item no.: 2009-115/000-024</b> WMB-Inline; for smartPRINTER; on reel; stretchable 5 - 5.2 mm; plain; snap-on type	/000-024	2009-115
	<b>Item no.: 209-140</b> Group marker carrier		209-140
	<b>Item no.: 209-141</b> Group marker carrier		209-141
	<b>Item no.: 209-142</b> Group marker carrier		209-142
	<b>Item no.: 209-185</b> Adaptor		209-185
	<b>Item no.: 793-501</b> WMB marking card; as card; not stretchable; plain; snap-on type		793-501
	<b>Item no.: 793-501/000-002</b> WMB marking card; as card; not stretchable; plain; snap-on type	/000-002	793-501
	<b>Item no.: 793-501/000-005</b> WMB marking card; as card; not stretchable; plain; snap-on type	/000-005	793-501
	<b>Item no.: 793-501/000-006</b> WMB marking card; as card; not stretchable; plain; snap-on type	/000-006	793-501
	<b>Item no.: 793-501/000-007</b> WMB marking card; as card; not stretchable; plain; snap-on type	/000-007	793-501
	<b>Item no.: 793-501/000-012</b> WMB marking card; as card; not stretchable; plain; snap-on type	/000-012	793-501
	<b>Item no.: 793-501/000-017</b> WMB marking card; as card; not stretchable; plain; snap-on type	/000-017	793-501

	<b>Item no.: 793-501/000-023</b> WMB marking card; as card; not stretchable; plain; snap-on type	793-501 /000-023
	<b>Item no.: 793-501/000-024</b> WMB marking card; as card; not stretchable; plain; snap-on type	793-501 /000-024
	<b>Item no.: 793-5501</b> WMB marking card; as card; for terminal block width 5 - 17.5 mm; stretchable 5 - 5.2 mm; plain; snap-on type	793-5501
	<b>Item no.: 793-5501/000-002</b> WMB marking card; as card; for terminal block width 5 - 17.5 mm; stretchable 5 - 5.2 mm; plain; snap-on type	793-5501 /000-002
	<b>Item no.: 793-5501/000-005</b> WMB marking card; as card; stretchable 5 - 5.2 mm; plain; snap-on type	793-5501 /000-005
	<b>Item no.: 793-5501/000-006</b> WMB marking card; as card; stretchable 5 - 5.2 mm; plain; snap-on type	793-5501 /000-006
	<b>Item no.: 793-5501/000-007</b> WMB marking card; as card; stretchable 5 - 5.2 mm; plain; snap-on type	793-5501 /000-007
	<b>Item no.: 793-5501/000-012</b> WMB marking card; as card; stretchable 5 - 5.2 mm; plain; snap-on type	793-5501 /000-012
	<b>Item no.: 793-5501/000-017</b> WMB marking card; as card; stretchable 5 - 5.2 mm; plain; snap-on type	793-5501 /000-017
	<b>Item no.: 793-5501/000-023</b> WMB marking card; as card; stretchable 5 - 5.2 mm; plain; snap-on type	793-5501 /000-023
	<b>Item no.: 793-5501/000-024</b> WMB marking card; as card; stretchable 5 - 5.2 mm; plain; snap-on type	793-5501 /000-024
<b>General accessories</b>		
	<b>Item no.: 249-105</b> Group marker carrier	249-105
	<b>Item no.: 249-147</b> B-type test plug module; modular	249-147
	<b>Item no.: 249-148</b> B-type spacer module; modular; e.g., for bridging commoned terminal blocks	249-148
	<b>Item no.: 280-404</b> Test plug adapter; 5 mm wide; for test plug 210-137 (2.3 mm Ø); suitable for 1.5 mm <sup>2</sup> - 4 mm <sup>2</sup> tbs	280-404
	<b>Item no.: 281-407</b> Test plug; 6 mm wide; Nominal current 24 A; for 0.08 mm <sup>2</sup> - 2.5 mm <sup>2</sup>	281-407

	<b>Item no.: 281-418</b> Test plug module; modular; suitable for all WAGO 281, 776, 777 and 781 series rail-mounted terminal blocks with jumper slots in the current bar	281-418
	<b>Item no.: 281-419</b> Spacer module; modular; bridging commoned terminal blocks	281-419
<b>ferrule</b>		
	<b>Item no.: 216-106</b> Ferrule; Sleeve for 2.5 mm <sup>2</sup> / AWG 14; uninsulated; electro-tin plated	216-106
	<b>Item no.: 216-201</b> Ferrule; Sleeve for 0.5 mm <sup>2</sup> / 20 AWG; insulated; electro-tin plated	216-201
	<b>Item no.: 216-202</b> Ferrule; Sleeve for 0.75 mm <sup>2</sup> / 18 AWG; insulated; electro-tin plated	216-202
	<b>Item no.: 216-203</b> Ferrule; Sleeve for 1 mm <sup>2</sup> / AWG 18; insulated; electro-tin plated	216-203
	<b>Item no.: 216-204</b> Ferrule; Sleeve for 1.5 mm <sup>2</sup> / AWG 16; insulated; electro-tin plated	216-204
	<b>Item no.: 216-205</b> Ferrule; Sleeve for 2.08 mm <sup>2</sup> / AWG 14; insulated; electro-tin plated	216-205
	<b>Item no.: 216-206</b> Ferrule; Sleeve for 2.5 mm <sup>2</sup> / AWG 14; insulated; electro-tin plated	216-206
	<b>Item no.: 216-241</b> Ferrule; Sleeve for 0.5 mm <sup>2</sup> / 20 AWG; insulated; electro-tin plated; electrolytic copper; gastight crimped; acc. to DIN 46228, Part 4/09.90	216-241
	<b>Item no.: 216-242</b> Ferrule; Sleeve for 0.75 mm <sup>2</sup> / 18 AWG; insulated; electro-tin plated; electrolytic copper; gastight crimped; acc. to DIN 46228, Part 4/09.90	216-242
	<b>Item no.: 216-243</b> Ferrule; Sleeve for 1 mm <sup>2</sup> / AWG 18; insulated; electro-tin plated; electrolytic copper; gastight crimped; acc. to DIN 46228, Part 4/09.90	216-243
	<b>Item no.: 216-244</b> Ferrule; Sleeve for 1.5 mm <sup>2</sup> / AWG 16; insulated; electro-tin plated; electrolytic copper; gastight crimped; acc. to DIN 46228, Part 4/09.90	216-244
	<b>Item no.: 216-246</b> Ferrule; Sleeve for 2.5 mm <sup>2</sup> / AWG 14; insulated; electro-tin plated; electrolytic copper; gastight crimped; acc. to DIN 46228, Part 4/09.90	216-246
	<b>Item no.: 216-301</b> Ferrule; Sleeve for 0.25 mm <sup>2</sup> / AWG 24; insulated; electro-tin plated	216-301
	<b>Item no.: 216-302</b> Ferrule; Sleeve for 0.34 mm <sup>2</sup> / 22 AWG; insulated; electro-tin plated	216-302
<b>tools</b>		
	<b>Item no.: 210-657</b> Operating tool with partially insulated shaft; Blade (3.5 x 0.5) mm; short	210-657
	<b>Item no.: 210-658</b> Operating tool with partially insulated shaft; Blade (3.5 x 0.5) mm; short; angled	210-658



Item no.: 210-720

210-720

Operating tool with partially insulated shaft; Type 2, blade (3.5 x 0.5) mm

## End plate



Item no.: 281-316

281-316

End and intermediate plate; 3 mm thick



Item no.: 281-317

281-317

End and intermediate plate; 3 mm thick



Item no.: 281-327

281-327

Separator plate; 2 mm thick; oversized



Item no.: 281-337

281-337

Separator plate; 2 mm thick; oversized



Item no.: 284-334

284-334

Step-down cover plate; 1 mm thick; for 2-, 3- and 4-conductor terminal blocks



Item no.: 284-344

284-344

Step-down cover plate; 1 mm thick; for 2-, 3- and 4-conductor terminal blocks

## Downloads

## CAD/CAE - Smart Data

## CAD data

3D Download 281-601

URL

Download

Subject to changes.